

180AR-1/180AR-2/180AR-3

INTERFACE A1 EQUIPMENT BUSHINGS

APPLICATION

For use in equipment insulated with oil fluid, typically for transformers, switchgear, capacitors...

TECHNICAL CHARACTERISTICS

Each bushing is tested for AC withstand and partial discharge prior to leaving the factory.

DESIGN

- The equipment bushings are moulded epoxy insulated parts in accordance with CENELEC EN 50180.
The 180AR-2 bushing has a length B outside this standard.
- The standard bushings, (K)180AR-1 /-2 /-3, are equipped with 6 tabs for the bail restraint.
- The (K)180AR-1-G and (K)180AR-3-G are equipped with 4 tabs and 2 threaded inserts M6 (-G version).

ORDERING INSTRUCTIONS

To order the equipment bushing, specify the type.
The bushings are supplied with an earth jumper (/J) or an earth plate (/GS). This earth connection must be specified when ordering.
E.g. K180AR-1/J.

SPECIFICATIONS AND STANDARDS

The plug-in type equipment bushings 180AR-... meet the requirements of CENELEC EN 50180 and IEC 60137.



Type 180AR-1 /-2 /-3

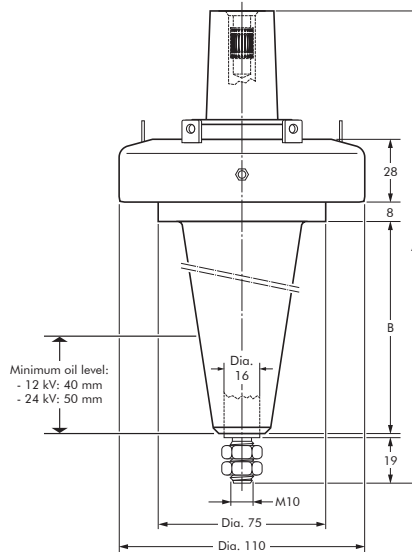

Type 180AR-1-G /-3-G

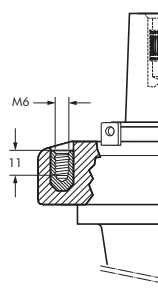

6/10 (12) kV
6.35/11 (12) kV
8.7/15 (17.5) kV
12/20 (24) kV
12.7/22 (24) kV

Up to 24 kV - 250 A

EUROMOLD®

In mm.

Equipment bushing type	Voltage Um (kV)	Current Ir (A)	Dimensions (mm)	
			A	B
180AR-1	12	250	222	106
K180AR-1	24	250	222	106
180AR-2	12	250	284	168
K180AR-2	24	250	284	168
180AR-3	12	250	171	55
K180AR-3	24	250	171	55

02/2020

FIXINGS FOR EQUIPMENT BUSHINGS

180AR-1/GS
180AR-1-G/GS
180AR-2/GS
180AR-3/GS AND
180AR-3-G/GS BUSHINGS

180AR-1/J
180AR-1-G/J
180AR-2/J
180AR-3/J AND
180AR-3-G/J BUSHINGS

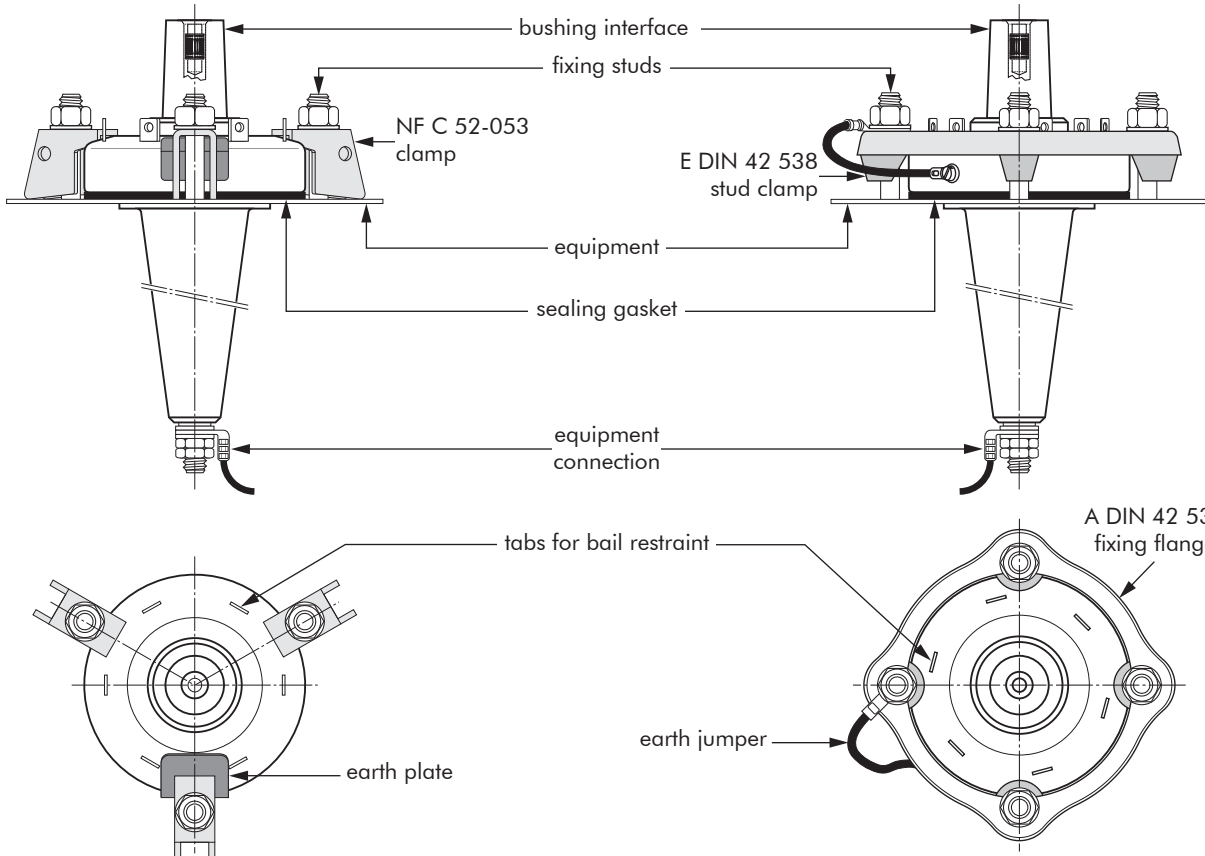

BUSHING CLAMPING KIT

To order the bushing clamping kit, according to NF C 52-053 standards, simply specify: KBC – NFC 52-053 /200 SERIES.
Contents: - 3 x claw clamp NF
- 1 x sealing gasket.

BUSHING CLAMPING KIT

To order the bushing clamping kit, according to DIN 42 538 standards, simply specify: KBC - RING CLAMP 1.
Contents: - 1 x fixing flange A
- 4 x stud clamp E
- 1 x sealing gasket.

FIXING DIMENSIONS STANDARDS NF C 52-053

French standards.

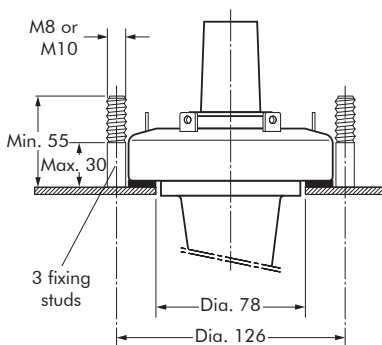

FIXING DIMENSIONS STANDARDS DIN 42 538

German standards.

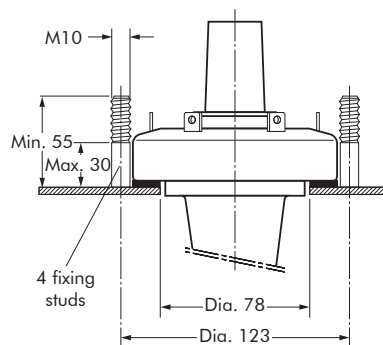

In mm.